

Season/Year	Spring 2018	Brand	NAUTICA	Testing Level	3
Dev No	NC-S18-000003	Designer	DAVID SONG	In Store Date	
Proj # (SR#)	299100	Developer	DAISY ZHU	Style Type	BNJ-Travel
Working Name	Modern Mariner HS	Modified By	David Song	Status	Spec Pending
Final Name		Modified Date	2/15/2017		
Bench Program	2592_NAUTICA TORPEDO	Start Date	1/7/2017		

SR299100_01_NAUTICA_SP18_FP_HS



Spring 2018

SR299100.01.NAUTICA.SP18.FP.HS



Season/Year	Spring 2018	Brand	NAUTICA	Testing Level	3
Dev No	NC-S18-000003	Designer	DAVID SONG	In Store Date	
Proj # (SR#)	299100	Developer	DAISY ZHU	Style Type	BNJ-Travel
Working Name	Modern Mariner HS	Modified By	David Song	Status	Spec Pending
Final Name		Modified Date	2/15/2017		
Bench Program	2592_NAUTICA TORPEDO	Start Date	1/7/2017		

SAMPLE REQUEST
 SAMPLE DELIVERY DATE:
 PROGRAM:
 STYLE/DESCRIPTION REFERENCE #:
 QUANTITY OF SAMPLES NEEDED:
 SAMPLE SIZE:
 SAMPLE COMMENTS:
 REQUESTED BY:

SAMPLE REFERENCE #
 VENDOR STYLE #

LUGGAGE 1											
STYLE INFO		FRAME		PIPING		COMPONENTS		FABRIC BACKING		INTERIOR	
Product #	299100	Top	None	Front Panel	N/A	Front Panel Corner Guards	N/A	Front Panel	N/A	Lining	Fully Lined - Heatseal - PUX2
Marketing Name	20 HQ	Side	None	Accent	N/A	Chassis Corner Guards	N/A	Side	N/A	Valet Strap	Yes - 3/4" Speckled Webbing
DIM UOM	Inches	Handle Side	None	Chasis	N/A	Footstud	Yes x 4	Top/Back/Bottom	N/A	Interior Logo	no
H (Height)	20	Back	None			Bottom Handle	None	EXP	PVC w Lining	Door Details	
W (Width)	14	Bottom Board	None			ID Tag	N/A			Chassis Lining	
D (Depth)	9	Top Handle	None			Add-a-Bag Strap	No				
Dim Exp	N/A	Side Handle	None								
Capacity Cu. In											
Product Weight											
Weight UOM											

Notes :

LUGGAGE 2											
STYLE INFO		FRAME		PIPING		COMPONENTS		FABRIC BACKING		INTERIOR	
Product #	299100	Top	None	Front Panel	N/A	Front Panel Corner Guards	N/A	Front Panel	N/A	Lining	Fully Lined - Heatseal - PUX2
Marketing Name	24" HQX	Side	None	Accent	N/A	Chassis Corner Guards	N/A	Side	N/A	Valet Strap	Yes - 3/4" Speckled Webbing
DIM UOM	Inches	Handle Side	None	Chasis	N/A	Footstud	Yes x 4	Top/Back/Bottom	N/A	Interior Logo	no
H (Height)	24"	Back	None			Bottom Handle	None	EXP	PVC w Lining	Door Details	
W (Width)	16.5"	Bottom Board	None			ID Tag	N/A			Chassis Lining	
D (Depth)	11"	Top Handle	None			Add-a-Bag Strap	No				
Dim Exp	2"	Side Handle	None								
Capacity Cu. In											
Product Weight											
Weight UOM											

Notes :

LUGGAGE 3											
STYLE INFO		FRAME		PIPING		COMPONENTS		FABRIC BACKING		INTERIOR	
Product #	299100	Top	None	Front Panel	N/A	Front Panel Corner Guards	N/A	Front Panel	N/A	Lining	Fully Lined - Heatseal - PUx2
Marketing Name	28" HQX	Side	None	Accent	N/A	Chassis Corner Guards	N/A	Side	N/A	Valet Strap	Yes - 3/4" Speckled Webbing
DIM UOM	Inches	Handle Side	None	Chasis	N/A	Footstud	Yes x 4	Top/Back/Bottom	N/A	Interior Logo	no
H (Height)	28"	Back	None			Bottom Handle	None	EXP	PVC w Lining	Door Details	
W (Width)	19"	Bottom Board	None			ID Tag	N/A			Chassis Lining	
D (Depth)	13"	Top Handle	None			Add-a-Bag Strap	No				
Dim Exp	2"	Side Handle	None								
Capacity Cu. In											
Product Weight											
Weight UOM											
Notes :											

Main Material



Main BNJ - Components

Image	Material Code	Description	Category	Subcategory	Sub Category Type	Material Supplier	Supplier Style No	Size
	COM-HS-00028	Small grid Texture - 100% ABS	Hardside Shell	ABS	Textured			

BNJ - Textiles

Image	Material Code	Description	Category	Subcategory	Sub Category Type	Supplier	Supplier Style No	Coating	Backing
	TEX-?00012	INTERIOR BINDING							
	TEX-TEXP-00002	150D Plain Poly Lining		Plain Poly	150D				
	TEX-TEXP-00036	Plain 600D Fabric		Plain Poly	600D				

BNJ - Components



Image	Material Code	Description	Category	Subcategory	Sub Category Type	Material Supplier	Supplier Style No	Size
	COM-01TRY-00069	SP-138	Trolley	Shortbound Trolley	Steel	SANPU	SP - 138	
	COM-01TRY-00073	Trolley Tubes	Trolley					
	COM-01WH-00145	Fengyu C-126	Wheels	Hardside Wheels	2 Wheels	Fengyu 丰裕 Jiaxing	C-126	
	COM-01WH-00146	Wheel Housing	Wheels					
	COM-01WH-00147	Wheel Fork	Wheels					
	COM-01WH-00148	Rubber Tire	Wheels					
	COM-01WH-00149	Wheel Base	Wheels					

























































	COM-01WH-00150	Wheel Cover	Wheels					
	COM-03HAN-00047	BAIXING LX-020	Carry Handles	Injected			LX - 020	
	COM-06LO-00173	Triangle Sport Logo NAUTICA	Logos	Metal Plaque/CoMolded		HARRY METAL		
	COM-TL-00010	Jintaixiang-ZL543	TSA Lock	Hardside Integrated			ZL543	
	COM-02FT-00023	Qianshun - QS - Q25	Feet	Injected Feet	Side Feet - Low Profile			
	COM-07PUL-00077	NAUTICA TSA Puller	Pullers	Metal				
	COM-?00012	PVC ZIPPER HOUSING FOR HARDSIDE	Hardside Shell					
	COM-08ZIP-00002	#8 Zipper Tape Coil	Zipper Tape	Coil	Standard			
	COM-08ZIP-00004	#5 Zipper Tape Coil	Zipper Tape	Coil	Standard			
	COM-08ZIP-00003	#3 Zipper Tape Coil	Zipper Tape	Coil	Standard			
	COM-07SL-00006	#8 Slider	Sliders	Standard	8.0mm			
	COM-07SL-00002	#5 Slider	Sliders	Standard	5.0mm			
	COM-07SL-00003	#3 Slider	Sliders	Standard	3.0mm			
	COM-10WEBC-00080	Duraflex 3/4" SR Clip: 1-21149-1-22149	Webbing Component	SR Buckles	Single Adjust		Duraflex: 1-21149-1-22149	

BNJ - Tooling

Image	Material Code	Description	Category	Subcategory	Sub Category Type	Supplier	Supplier Style No
	TLG-TOL6-00004	NAUTICA Sail Repeat Heat Seal Roller	Heat Emboss Rollers				

BNJ - Trims

Image	Material Code	Description	Category	Subcategory	Sub Category Type	Supplier	Supplier Style No	Finish	Backing Type	Substance/Thickness
	TRM-04WEBT-00038	Signature Nautica Webbing	Webbing Woven	Polyester	Flat					1.0 - 1.2 mm
	TRM-04WEBT-00065	3/4" Speckled Webbing	Webbing Woven	Polypropylene	Flat					
	TRM-08MSH-00012	GENERIC OPEN MESH	Mesh	Open Plain Mesh						

Material Description	Placement	Qty	Size	CargoBlue/Neutral Gry	ClassicGrey/PeacockB	ClassicRed/Neutra IGr	MustardField/MonocoB
(COM-HS-00028) Small grid Texture - 100% ABS	ABS	0.00		 (19-4329 TCX) Cargo Blue	 (PANTONE 18-3907 TCX) Classic Grey	 (19-1862 TCX) Classic Red	 (13-0942 TCX) Lighthouse Yellow
(TEX-?00012) INTERIOR BINDING	Interior	0.00		 (17-4402 TCX) Neutral Gray	 (16-4728 TCX) Peacock Blue	 (17-4402 TCX) Neutral Gray	 (PANTONE 19-3964 TCX) Monaco Blue
(TEX-TEXP-00002) 150D Plain Poly Lining	Lining	0.00		 (17-4402 TCX) Neutral Gray	 (16-4728 TCX) Peacock Blue	 (17-4402 TCX) Neutral Gray	 (PANTONE 19-3964 TCX) Monaco Blue
(TEX-TEXP-00036) Plain 600D Fabric	Expansion & Laptop Sleeve	0.00		 (17-4402 TCX) Neutral Gray	 (16-4728 TCX) Peacock Blue	 (17-4402 TCX) Neutral Gray	 (PANTONE 19-3964 TCX) Monaco Blue
(COM-01TRY-00069) SP-138	Trolley Component	0.00		 (19-4329 TCX) Cargo Blue	 (PANTONE 18-3907 TCX) Classic Grey	 (19-1862 TCX) Classic Red	 (13-0942 TCX) Lighthouse Yellow
(COM-01TRY-00073) Trolley Tubes	Tube Color	0.00		 (19-0303 TCX) Jet Black	 (19-0303 TCX) Jet Black	 (19-0303 TCX) Jet Black	 (19-0303 TCX) Jet Black
(COM-01WH-00145) Fengyu C-126	Wheel Component	0.00					
(COM-01WH-00146) Wheel Housing	Wheel Component	0.00		 (19-4329 TCX) Cargo Blue	 (PANTONE 18-3907 TCX) Classic Grey	 (19-1862 TCX) Classic Red	 (13-0942 TCX) Lighthouse Yellow
(COM-01WH-00147) Wheel Fork	Wheel Component	0.00		 (19-0303 TCX) True Black	 (19-0303 TCX) True Black	 (19-0303 TCX) True Black	 (19-0303 TCX) True Black
(COM-01WH-00148) Rubber Tire	Wheel Component	0.00		 (19-0303 TCX) True Black	 (19-0303 TCX) True Black	 (19-0303 TCX) True Black	 (19-0303 TCX) True Black
(COM-01WH-00149) Wheel Base	Wheel Component	0.00		 (17-4402 TCX) Neutral Gray	 (16-4728 TCX) Peacock Blue	 (17-4402 TCX) Neutral Gray	 (PANTONE 19-3964 TCX) Monaco Blue
(COM-01WH-00150) Wheel Cover	Wheel Component	0.00		 (19-4329 TCX) Cargo Blue	 (PANTONE 18-3907 TCX) Classic Grey	 (19-1862 TCX) Classic Red	 (13-0942 TCX) Lighthouse Yellow
(COM-03HAN-00047) BAIXING LX-020	Carry Handles	0.00		 (19-0303 TCX) True Black	 (19-0303 TCX) True Black	 (19-0303 TCX) True Black	 (19-0303 TCX) True Black
(COM-06LO-00173) Triangle Sport Logo NAUTICA	Logo Plaque	0.00		 (19-0303 TCX) True Black	 (19-0303 TCX) True Black	 (19-0303 TCX) True Black	 (19-0303 TCX) True Black

Material Description	Placement	Qty	Size	CargoBlue/Neutral Gry	ClassicGrey/PeacockB	ClassicRed/Neutra IGr	MustardField/MonocoB
(COM-TL-00010) Jintaixiang-ZL543	DTM TSA Lock	0.00		 (19-4329 TCX) Cargo Blue	 (PANTONE 18-3907 TCX) Classic Grey	 (19-1862 TCX) Classic Red	 (13-0942 TCX) Lighthouse Yellow
(COM-02FT-00023) Qianshun - QS - Q25	Foot Studs	0.00		 (19-0303 TCX) True Black	 (19-0303 TCX) True Black	 (19-0303 TCX) True Black	 (19-0303 TCX) True Black
(COM-07PUL-00077) NAUTICA TSA Puller	Main Opening	0.00		 (shiny nick) Shiny Nickel	 (shiny nick) Shiny Nickel	 (shiny nick) Shiny Nickel	 (shiny nick) Shiny Nickel
(COM-?00012) PVC ZIPPER HOUSING FOR HARDSIDE	Zipper Housing	0.00		 (19-0303 TCX) Jet Black	 (19-0303 TCX) Jet Black	 (19-0303 TCX) Jet Black	 (19-0303 TCX) Jet Black
(COM-08ZIP-00002) #8 Zipper Tape Coil	Main Opening & Expansion	0.00		 (17-4402 TCX) Neutral Gray	 (16-4728 TCX) Peacock Blue	 (17-4402 TCX) Neutral Gray	 (PANTONE 19-3964 TCX) Monaco Blue
(COM-08ZIP-00004) #5 Zipper Tape Coil	Interior Pockets	0.00		 (17-4402 TCX) Neutral Gray	 (16-4728 TCX) Peacock Blue	 (17-4402 TCX) Neutral Gray	 (PANTONE 19-3964 TCX) Monaco Blue
(COM-08ZIP-00003) #3 Zipper Tape Coil	Repair Access	0.00		 (17-4402 TCX) Neutral Gray	 (16-4728 TCX) Peacock Blue	 (17-4402 TCX) Neutral Gray	 (PANTONE 19-3964 TCX) Monaco Blue
(COM-07SL-00006) #8 Slider	Main Opening & Expansion	0.00		 (shiny nick) Shiny Nickel	 (shiny nick) Shiny Nickel	 (shiny nick) Shiny Nickel	 (shiny nick) Shiny Nickel
(COM-07SL-00002) #5 Slider	Interior Pockets	0.00		 (shiny nick) Shiny Nickel	 (shiny nick) Shiny Nickel	 (shiny nick) Shiny Nickel	 (shiny nick) Shiny Nickel
(COM-07SL-00003) #3 Slider	Repair Access	0.00		 (shiny nick) Shiny Nickel	 (shiny nick) Shiny Nickel	 (shiny nick) Shiny Nickel	 (shiny nick) Shiny Nickel
(COM-10WEBC-00080) Duraflex 3/4" SR Clip: 1-21149-1-22149	Interior	0.00		 (19-4329 TCX) Cargo Blue	 (PANTONE 18-3907 TCX) Classic Grey	 (19-1862 TCX) Classic Red	 (13-0942 TCX) Lighthouse Yellow
(TLG-TOL6-00004) NAUTICA Sail Repeat Heat Seal Roller	Heat Seal Repeat on Lining	0.00					
(TRM-04WEBT-00038) Signature Nautica Webbing	Expansion + Interior Puller	0.00		 Navy / white	 Navy / white	 Navy / white	 Navy / white
(TRM-04WEBT-00065) 3/4" Speckled Webbing	Interior	0.00		 (19-0303 TCX) True Black	 (19-0303 TCX) True Black	 (19-0303 TCX) True Black	 (19-0303 TCX) True Black
(TRM-08MSH-00012) GENERIC OPEN MESH	Interior	0.00		 (17-4402 TCX) Neutral Gray	 (16-4728 TCX) Peacock Blue	 (17-4402 TCX) Neutral Gray	 (PANTONE 19-3964 TCX) Monaco Blue

FEATURES & CONSTRUCTION

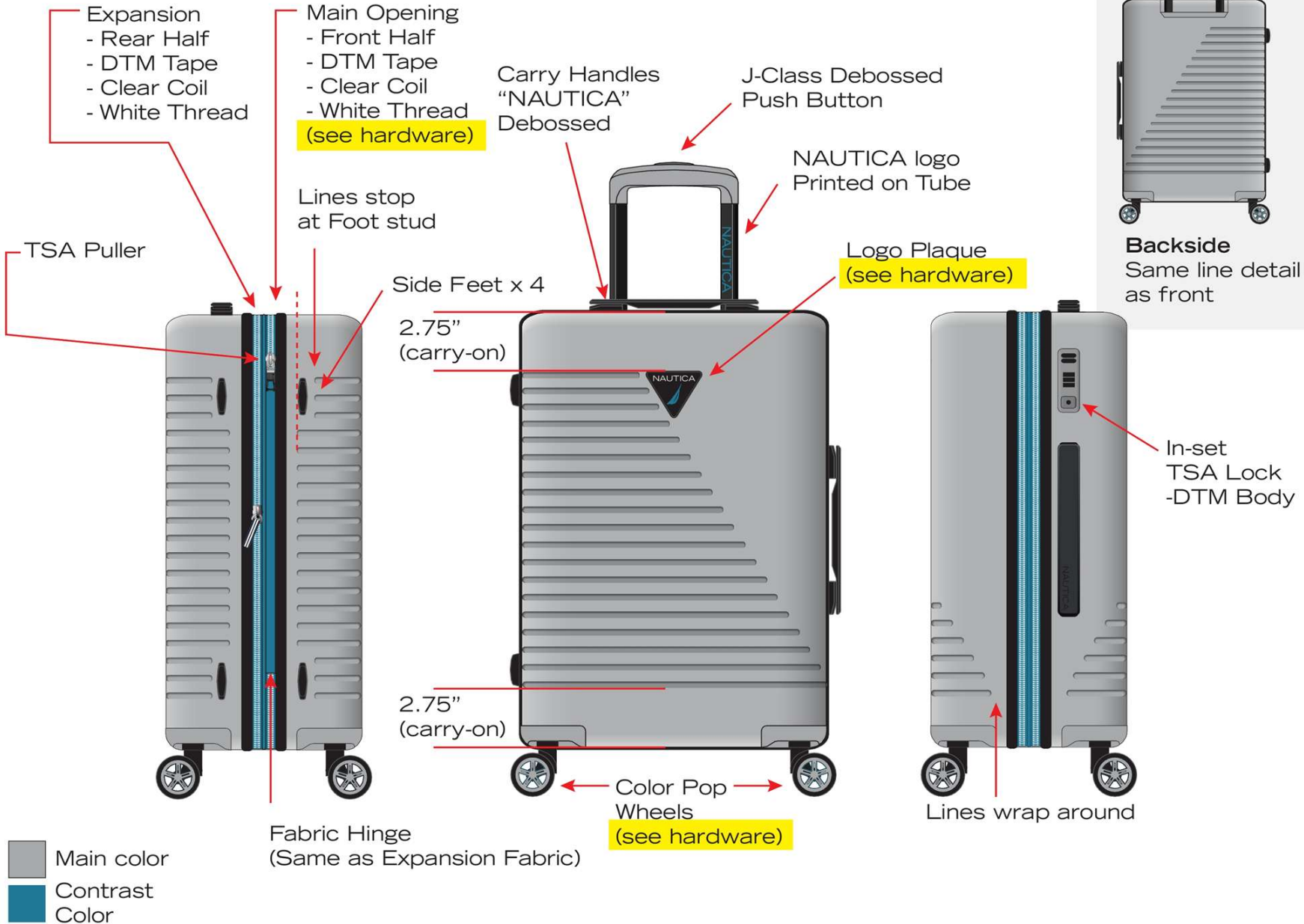

INTERIOR



3/4" Speckled Webbing



Main color
 Contrast Color

CARRY-ON SPECIAL CONSTRUCTION

- No Expansion
- Laptop Sleeve integrated

- Hanging Sleeve
- attached on Rear Shell (under zipper housing)
 - attached on Piping

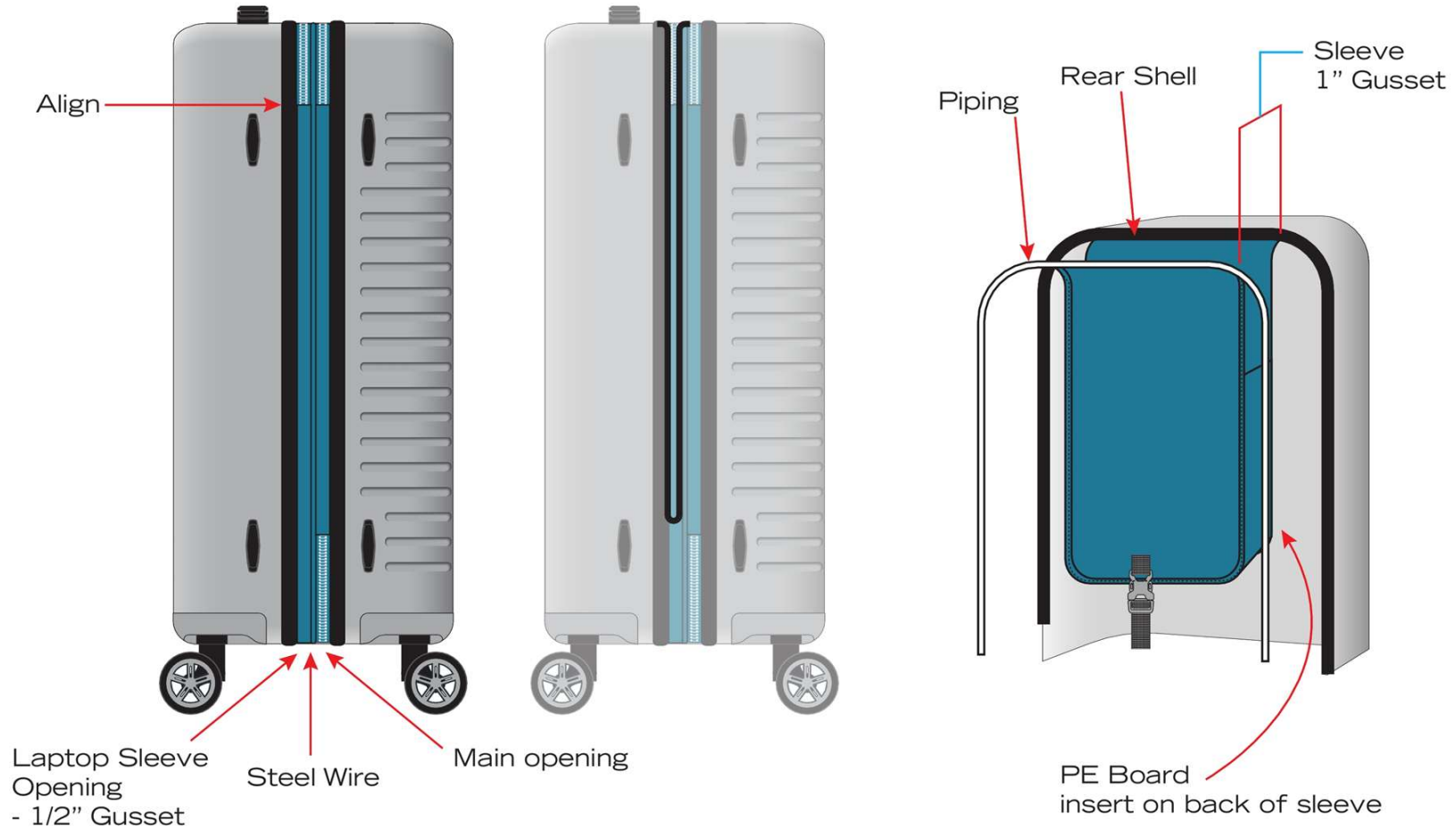

CARRY-ON SPECIAL CONSTRUCTION

- No Expansion
- Laptop Sleeve integrated
- Sleeve also to function like compression

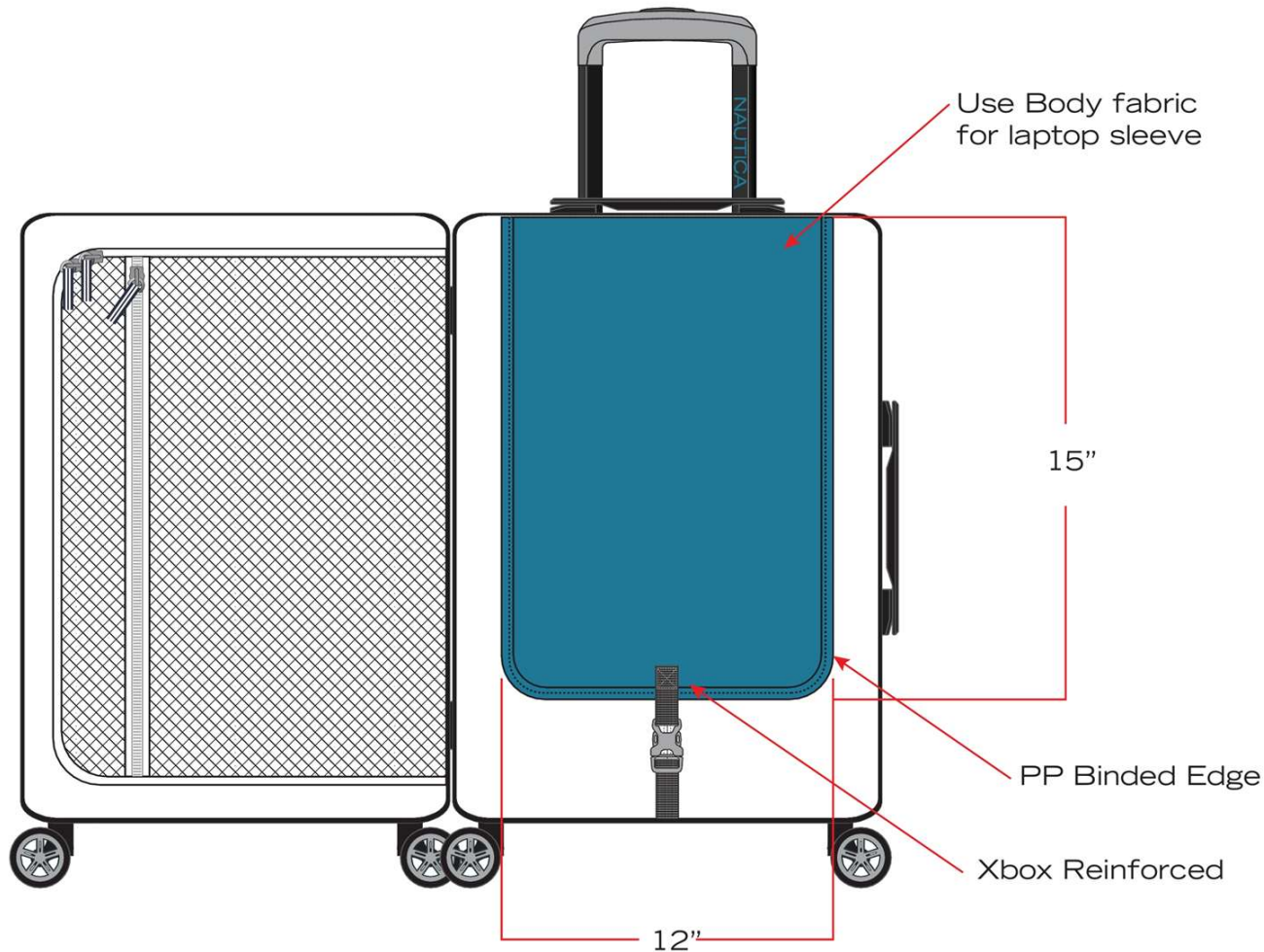

HEAT SEAL LINING - REPEAT

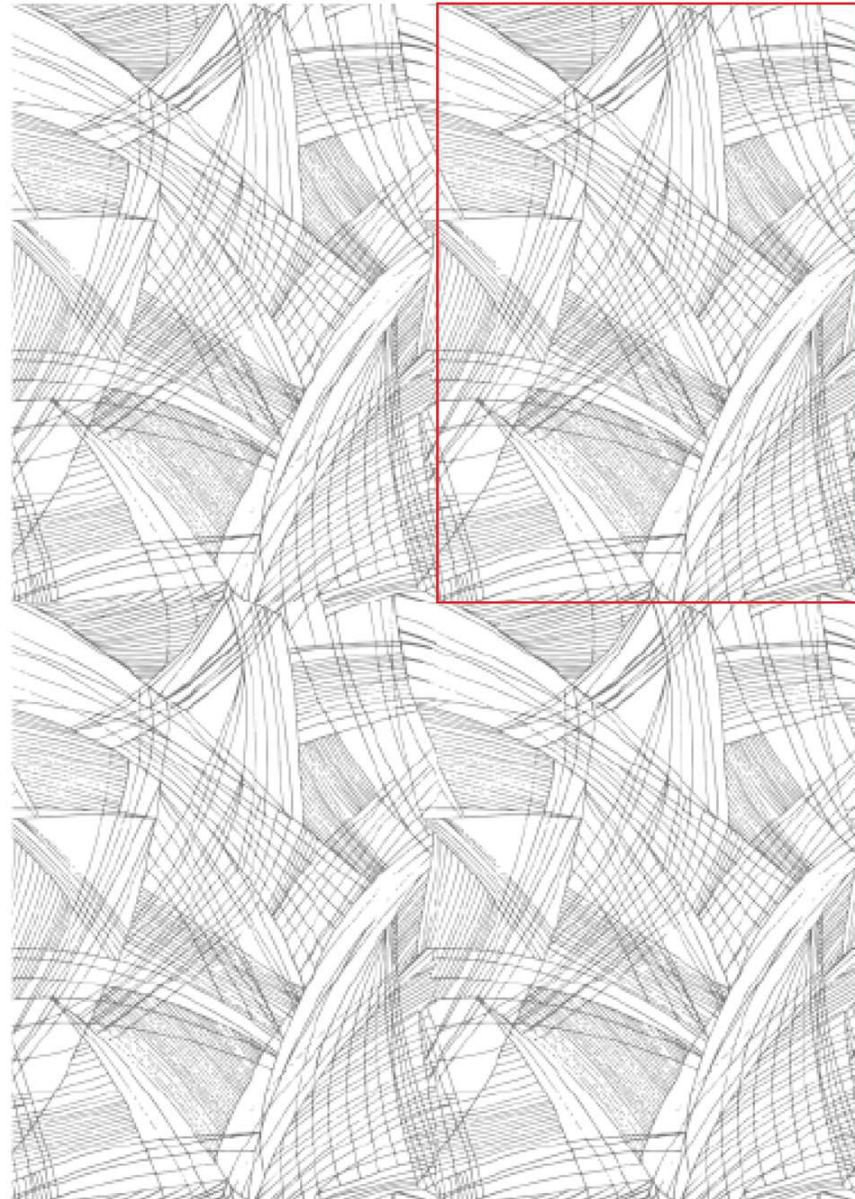
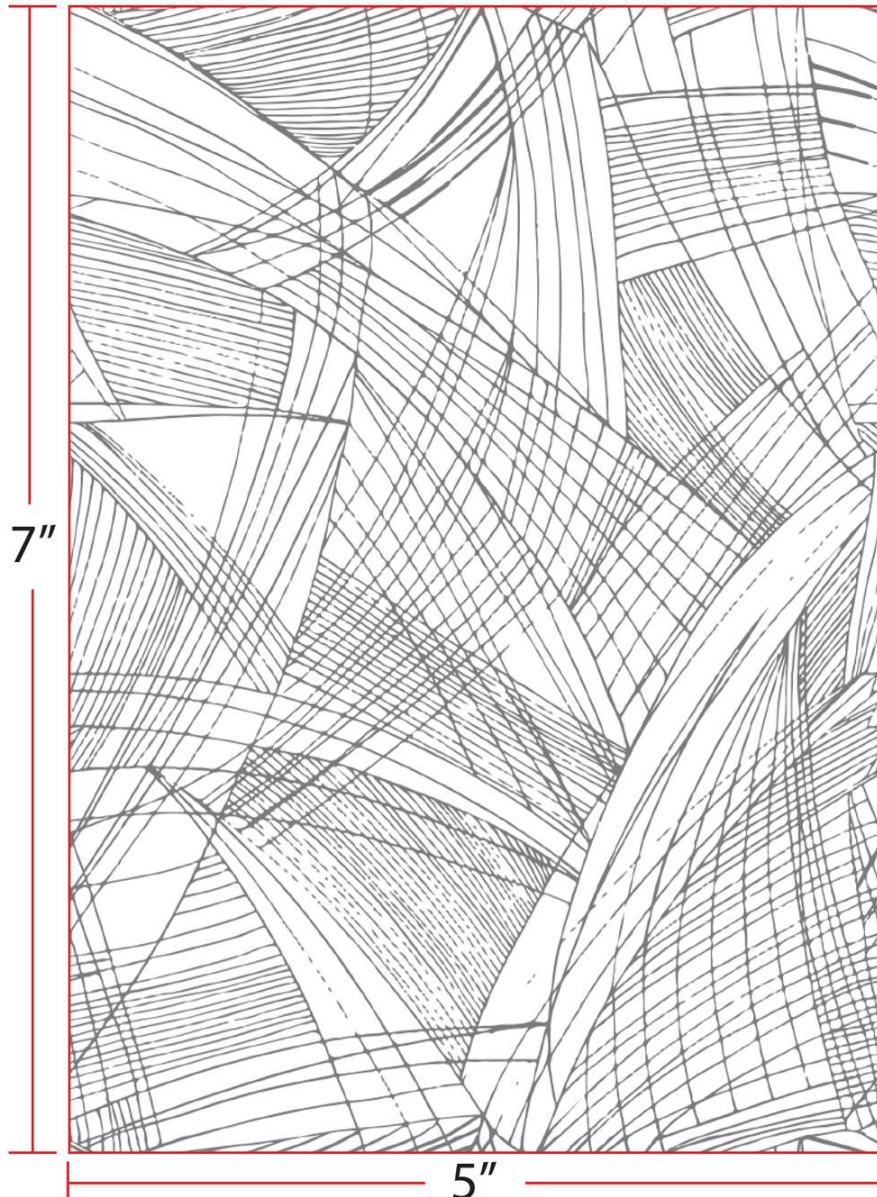

HARDWARE
Wheels

FengYu - C126

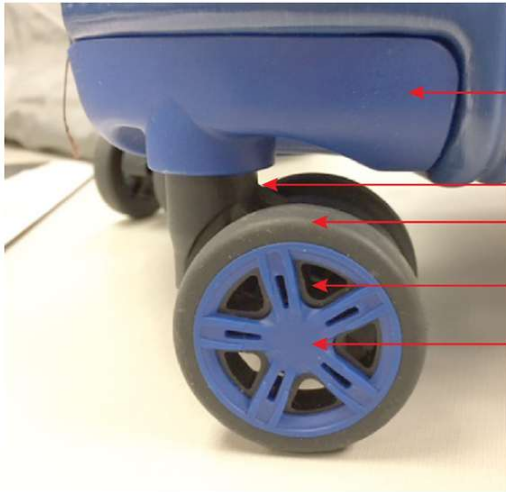

- Wheel Housing
- Wheel Fork
- Rubber Tire
- Wheel Base
- Wheel Cover

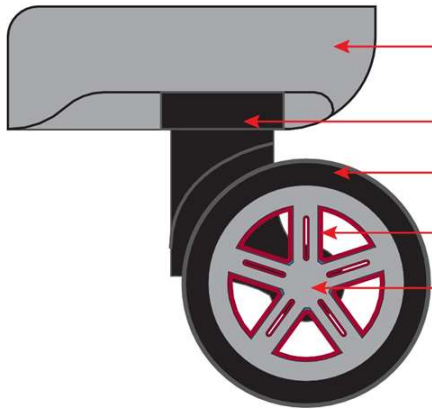

- Wheel Housing
- Wheel Fork
- Rubber Tire
- Wheel Base
- Wheel Cover

HARDWARE
SR Clip



Xlite® Buckle



Descript

- Thin profi
- Less mati

Material: Acetal(POM)

Size: Male/Female

5/8"(15mm)
Single Adjust 1-20300/1-20293
Non Adjust 1-20265/1-20293

3/4"(20mm)
Single Adjust 1-21149/1-22149
Dual Adjust 1-21149/1-20294
Dual Adjust-Thin 1-20301/1-20295
Non Adjust 1-20266/1-22149

1"(25mm)
Single Adjust 1-20302/1-20296
Dual Adjust 1-20302/1-20297
Dual Adjust-Thin 1-20303/1-20297
Non Adjust 1-30019/1-20296

HARDWARE
Zipper Tape



DTM Tape

Clear Coil

White Thread

- Main Opening
- Expansion / Laptop Opening

HARDWARE
Secondary Puller

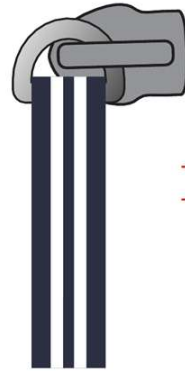

- Expansion / Laptop Opening
- Interior zipper puller

HARDWARE
Foot Studs



HARDWARE
Logo Plaque

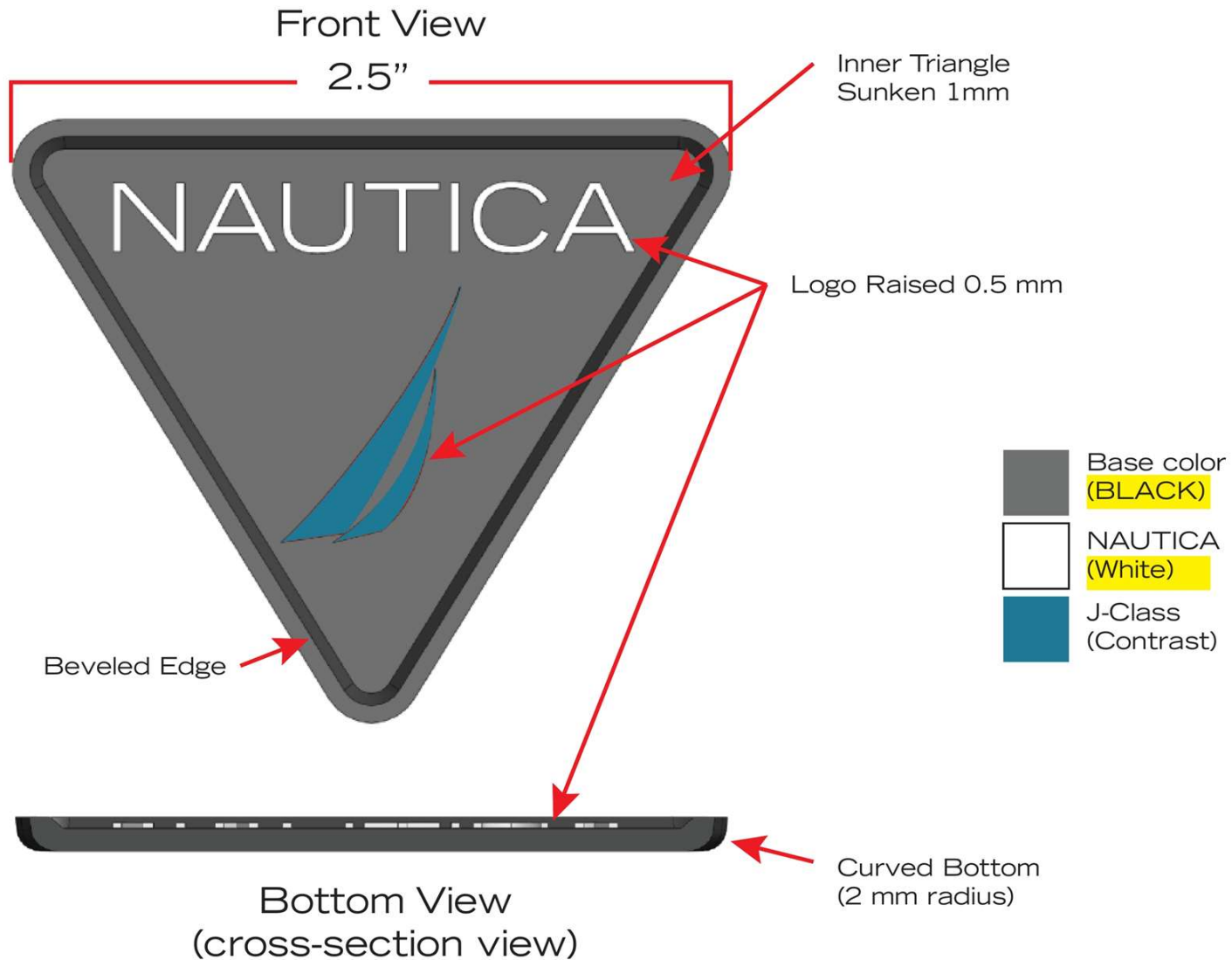

2:1 Scale Drawing

HARDWARE

Trolley Handle & Carry Handle

J-Class Debossed Trolley Handle



NAUTICA Debossed Carry Handle



COLOR COMBOS



- Cargo Blue
19-4329 TCX
- Neutral Grey
17-4402 TCX



- Classic Grey
18-3907 TCX
- Peacock Blue
16-4728 TCX



- Classic Red
19-1862 TCX
- Neutral Grey
17-4402 TCX



- Mustard Field
- Monoco Blue
19-3964 TCX

